



THERMAL MASS FLOW MEASUREMENT FOR GASES



Sage Metering:
*Pioneers of the In-Situ Calibration
Verification Procedure*



A Commitment to Higher Performance

SAGE METERING is a manufacturer of high performance Thermal Mass Flow Meters which measure the flow rate and consumption of gases for multiple industrial, municipal and commercial applications. Frequently used for energy management systems to monitor and improve energy efficiency as well as for regulatory compliance in environmental systems including carbon credit verification and flare gas monitoring.

TYPICAL APPLICATIONS include measurement and sub-metering of natural gas and compressed air for energy utilization and cost accounting within an industrial facility. Measurement of combustion air flow can be used for improving efficiency in boilers and furnaces. Monitoring of gas lines in campus or university building locations to assess energy inefficiencies. Monitor, detect and report methane leaks in the Oil and Gas Industry.

THERMAL MASS FLOW METERS offer economic advantages over traditional flow measurement technology. To meet the regulatory requirements of periodic re-calibration or calibration verification, Sage Metering has developed a unique in-situ accuracy verification process to ensure the meter is performing within the original NIST traceable gas calibration while the process remains in operation.

Sage Meters are used for all types of applications:

ENERGY MANAGEMENT

- Natural Gas Measurement
- Compressed Air Flows

ENVIRONMENTAL

- Methane Leak Detection
- Flare Gas
- Aeration Flow
- Greenhouse Gas Emissions
- Carbon Credits
- Biogas / Landfill Gas / Digester Gas

PROCESS

- Combustion Air
- Drying Air Flow
- Vent Air
- Boiler or Furnace Optimization

FACILITIES MANAGEMENT

- Natural Gas Submetering
- Department Cost Allocation
- Leak Detection

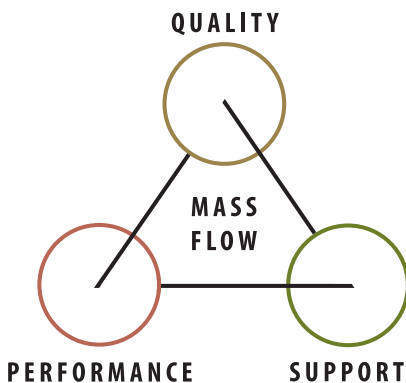

Experience and Expertise

SAGE METERING, INC. is one of the fastest growing Thermal Mass Flow Meter manufacturer in the industry. Founded in 2002, Sage brings together individuals with many years of combined experience in the design, operation, and application of Thermal Mass Flow Meters. This vast knowledge has enabled Sage to identify and improve on the overall design and performance of Thermal Mass Flow instrumentation. Sage's philosophy is inherent throughout its product line and services.

Innovative Products

On Time Delivery

Extraordinary Customer Service

Strong Commitment to Quality

Excellent Responsiveness to Customers

Make the Wise Choice. Choose Sage Flow Meters.

A Pioneer in Technology Development

SAGE METERING has brought to market the first hybrid digitally-driven circuit design, eliminating the traditional analog Wheatstone bridge. This feature has provided Sage products with the ability to:

Eliminate analog drift, improving stability and long term reproducibility

Show a reproducible zero flow point, permitting simple and reliable calibration verification

Maintain higher resolution providing greater rangeability

Digitally-driven temperature sensor eliminates self-heating errors

Match overheat to application for greater signal resolution

First Thermal Mass Flow Meter with Bluetooth®

First Thermal Mass Flow Meter with Ethernet™

IN-SITU CALIBRATION VERIFICATION

User can easily verify that flow meter remains in calibration with simple field test while process is in operation

Checks overall instrument performance – both sensor and electronics

Eliminates the need for periodic factory re-calibration

Meets regulatory requirements for calibration check

FIRST GRAPHIC DISPLAY IN THERMAL FLOW INDUSTRY

Provides flow rate, temperature, totalized flow, diagnostics, and signal at a single glance

High contrast display easily readable, even outdoors

IMPROVED TEMPERATURE COMPENSATION

Ensure accurate flow measurement over wide range of process temperatures

ATTENTION TO ACCURACY

Calibrations performed on actual gas in closed-loop facility

NIST traceable calibration facility provides accuracy flexibility

NIST Traceable
Calibration

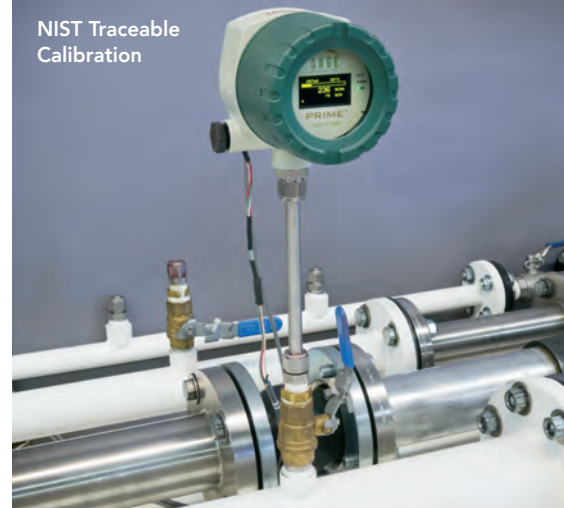

Compact
Design



Optional
Ethernet™

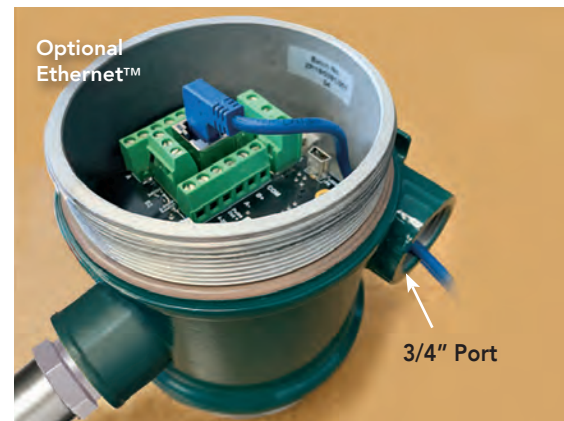

3/4" Port

High Velocity NIST
Calibration Facility



Sage Paramount™ Industrial Thermal Mass Flow Meter (400 Series)

The Sage Paramount™ Industrial Thermal Mass Flow Meter provides state-of-the-art components, a dual-sided, explosion-proof, NEMA 4X enclosure, a fast response to rapid temperature fluctuations, and a well-thought-out terminal arrangement with a 3-way switch for externally, or internally isolating the 4-20 mA or for non-isolated self-powered operation. Division 2 rating is standard; Division 1 rating is optional. If required, specify "DIV1".

One of the many compelling features of the Paramount™ is its accompanying free software, SageCom™. The SageCom™ software effortlessly connects the Sage Paramount™ to your PC via a separate mini USB connector¹ (cable supplied) located within the back terminal enclosure. Optionally, you can communicate between your laptop with SageCom™ software to the flow meter wirelessly via Bluetooth®, in lieu of using the USB cable to any nearby Paramount.

The innovative features of the new software permits the user to reconfigure the meter (change full scale, change pipe size [4" or larger], modify engineering units, and more). Also, you can change common gas constituents in the field, log real-time data, and validate the meter's operation through three different diagnostic steps, including the Sage In-Situ Calibration Verification. When finished, print a Validation Report complete with time and date stamps (ideal for QC departments, ISO).

Popular Options: Bluetooth® or Ethernet™ (Ethernet™/IP, Modbus/TCP or BACnet/IP).



401
Insertion Probe
shown with
SVA05 Mounting
Hardware

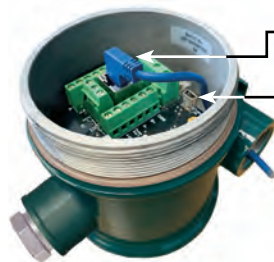

RJ45 Connector for optional Ethernet™
Separate communication channel for SageCom™ diagnostic software via supplied cable or optional Bluetooth® for wireless connectivity to multiple flow meters

Scan here
for terminal
details



Sage Prime™ Thermal Mass Flow Meter (SIP Series)

The Prime™ is Sage's long-standing Thermal Mass Flow Meter for all industrial and commercial applications. The Prime™ has been approved for use in hazardous areas by many agencies, plus CE rated for Electromagnetic compatibility.

Sage Prime™ has continuous diagnostics. The raw calibration milliwatts (mw) is always displayed in the upper left hand corner of the meter's display. At any time, you can check this reading at a "No Flow" (0 SCFM) condition, and compare the reading to the original reported "No Flow" value noted on the last few lines of your meter's Certificate of Conformance or the Flow Meter's data tag. This in-situ diagnostic procedure not only checks the sensor performance and the "Live Zero" calibration point, but it also verifies that the sensor is clean. It essentially provides a means to validate that the meter is operating properly, verifies that there is no shift or drift, and eliminates the need for annual factory calibrations. This simple field diagnostic procedure, in addition, verifies that the sensor is free from contamination, even without inspection.



SIP
Insertion
Probe

Remote Style of Paramount™ or Prime™



401 = Integral Paramount
402 = Remote Paramount
SIP = Integral Prime
SRP = Remote Prime
(Shown in above photo)

**Mounting
Hardware
Included**

MEASURING SPECIFICATIONS OF PARAMOUNT™ OR PRIME™	
Flow Accuracy	+/-0.5% of Full Scale +/-1% of Reading over a 100:1 Turndown
Turndown	100:1
Resolution	1000:1
Flow Repeatability	0.2%
Flow Response Time	1 second time constant (e.g. responds to 63% of a step change each second)
NIST Calibration Standards	0.25% of Rdg → 0.5% of Rdg of actual gas mixes
Low End Sensitivity	5 SFPM
Approvals ^{2,3}	See footnotes 2 and 3

¹Second communication channel via a mini USB connector (cable supplied) on Paramount™ only (features ability to have Modbus via USB connector, and Modbus or optionally HART™ off of the terminals). Ethernet™ optional.

ELECTRONICS AND OUTPUTS OF PARAMOUNT™ OR PRIME™	
Power Supply	24 VDC (18-28 VDC) or optional 115/230 VAC or 12 VDC with less approvals (Prime only)
Power Consumption	2.4 Watts Maximum
Flow Output	4-20 mA proportional to Gas Mass Flow Rate (0-100% Full Scale = 4-20 mA) internally powered; or customer selectable externally powered and isolated 4-20 mA
Totalizer (Pulsed Output)	24 VDC Pulse for Totalized Value Pulse Width (minimum 50 mSec) and Pulse Rate configurable (e.g. 10 SCF/pulse, etc.)
Relay Output	Available Externally (specify DCR-DC): SPDT 10 Amp contacts; activated from pulse
Communications ¹	Modbus compliant RS485 RTU (19200 baud [default] or 9600 baud) or optional BACnet. HART™ or Ethernet™ is optional on Paramount™ only.
Temperature Output	Through Modbus or SageCom™ software program
mW output (raw calibration data)	Through Modbus or SageCom™ software program

²All 24 VDC Powered Sage Paramount™ and Prime™ Meters are approved for Class I, Div. 2, Groups B, C, D, T4, UL/CSA, ANSI 12.12.01, and CE. ³Note, the Paramount optionally has Class I, Div. 1, Groups B, C, D, T4 approval, for both 24 VDC and 115 VAC meters (specify "DIV1").

SageCom™ Validation and Configuration Software

SageCom™ is a new, powerful, yet easy to use software program which gives the user testing, diagnostics, performance verification and local configuration capabilities for our family of Sage Thermal Mass Flow Meters¹. The unique software permits the user to easily perform a variety of diagnostic tests, offering reassurance that the Sage Flow Meter is performing per the original specifications. (Refer to SageCom™ Flyer [Rev. 5] for further information.)

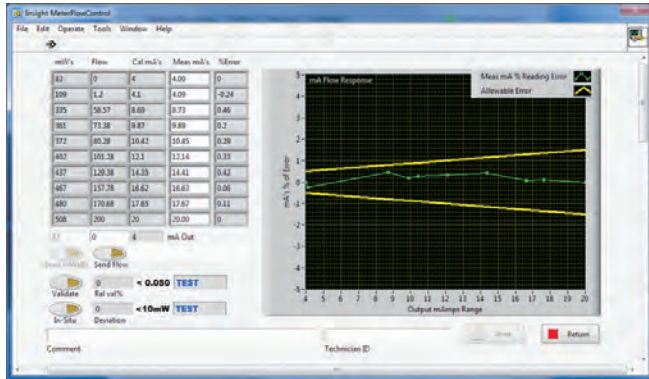

Diagnostic Screen

Software Reconfigurability¹

Check or change the configuration of the instrument, such as changing Full Scale, pipe size (4" or up), engineering units or decimal points

Software Diagnostics

- Multiple validation checks
- Generates linearization table with flow and mA
- Verifies sensor integrity
- Conducts In-Situ calibration verification
- Verifies that the meter hasn't drifted, shifted or changed since the original NIST calibration
- Reports a fault if contamination is present on the sensor
- Prints a Validation Report of diagnostic results

Change Gas Mix in the Field

With the Paramount, enter a new set of gas mix constituents versus the original calibrated mix, and the meter will automatically correct its readings to the new mix

Sage 200 / 300™ Thermal Mass Flow Meters

The Sage 200/300 Series™ Flow Meters provide the same high level of performance as the Sage Prime™ only with a more economical offering.

For more information on the Sage 200/300™ Thermal Mass Flow Meters, view the Products Tab on the Sage website by visiting: www.sagemetering.com

Agency approved for Class I Division 2 service

4-20 mA and pulse output

Optional Modbus output

Optional display of flow rate, total flow and temperature



Sage 200™ Meter shown with Insertion Probe



For more information on Sage Thermal Mass Flow Meters, go to www.sagemetering.com/product-literature-downloads/ or contact Sage at 866-677-SAGE (7243).

Flow Conditioning and Straight Run

To absolutely assure that the flow profile is well developed at the point of measurement, either use Flow Conditioners (which are standard for Sage In-Line Flow Meters, 1/2" and larger); or Flow Conditioner Assemblies, up to 36", for Insertion Flow Meters (see page 6). Otherwise, consider additional straight run. The chart below provides examples of the amount of straight run that would virtually assure that there are no flow disturbances at the point of measurement.

IMPORTANCE OF FLOW CONDITIONING Recommended Pipe Diameters Upstream

DISTURBANCE	WITHOUT Flow Conditioning	WITH Flow Conditioning ²
	SAGE Recommendation	SAGE Recommendation
One 90° Elbow	25	5
Two 90° Elbows in the same plane	36	7
Two 90° Elbows in different planes	62	11
4:1 Area Reduction	18	5
4:1 Area Expansion	84	12
Multiple Disturbance	TBD	TBD

¹SageCom™ provides full functionality with Sage Paramount™ and partial functionality with Sage Prime™

²This column applies to In-Line Flow Meters, which come standard with built-in Flow Conditioners, as well as Insertion Meters, when provided with upstream Captive Flow Conditioner

Flow Conditioning

Any insertion flow meter measures the flow at the location of the sensor. Therefore the overall accuracy of the flow measurement is dependent on the flow profile in the pipe.

With sufficient amount of straight pipe run, the desired flow profile naturally occurs. Sage recommends straight run distances which are dependent upon upstream and downstream pipe configuration. These recommended distances provide the expected flow profile at the sensor.

Often the desired amount of straight run is not available. In these situations, Sage Metering offers flow conditioning assemblies. They are easily installed between two flanges as shown to the right. When using a flow conditioning assembly, the recommended upstream straight run is greatly reduced. The use of a flow conditioner is a very simple method for obtaining the best possible overall accuracy.

Note, Sage in-line flow meters (1/2" and up) include built-in flow conditioners, thus minimizing the amount of upstream straight run that is required.

Typical Sage Flow Meter Installation Following a Single 90° Elbow without Sage Flow Conditioning

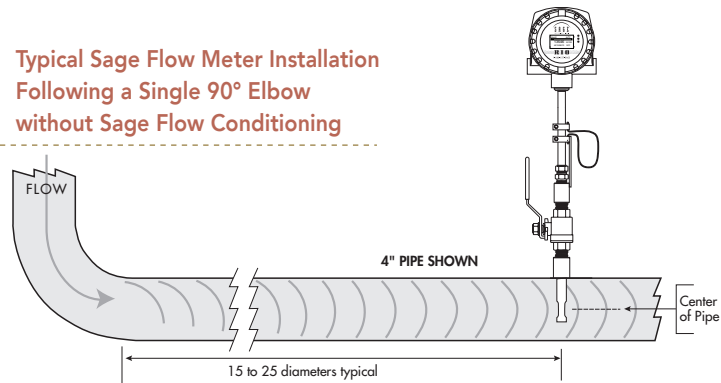

Typical Sage Thermal Mass Flow Meter Installation with Flow Conditioner Assembly¹

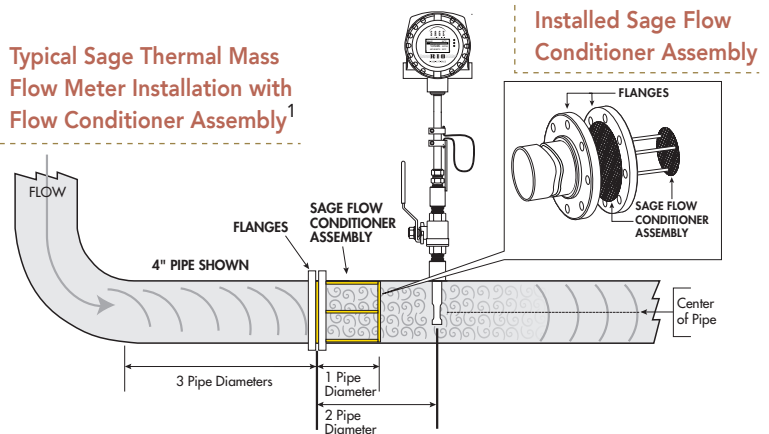

¹Optionally, order in-line flow meters (1/2" and up) since they include built-in flow conditioners



Sage Sensor Design

Sage offers the sensor in two different designs. The standard 1/2" diameter probe for general purpose use and the new 3/4" all welded design for heavy duty industrial applications, as well as ultra high velocity applications (35,000 SFPM; or up to 60,000 SFPM with reduced accuracy).

Installation Hardware

The Sage Flow Meter with insertion probe can easily be installed into a pipe or duct by using a 1/2" or 3/4" NPT connection for the 1/2" probe or a 1" NPT for the 3/4" probe. The two most common methods of installation are the SVA isolation valve assembly with a compression fitting or the simple STCF compression fitting. The compression fittings have Teflon ferrules which provide ease in installation and positioning the sensor. The use of the isolation valve¹ permits the probe to be removed while the process is in operation. Flange connections can also be provided to meet user's piping requirements.

¹Custom in-line flowmeters are optionally available with the isolation valve assembly inserted into a weldolet on the flow body. Please contact Sage.

PROBE LENGTH OF INSERTION PROBES

	STCF05/STCF07* Compression Fitting	SVA05LP Isolation Valve Low Pressure	SVA05/SVA07* Isolation Valve High Pressure
PIPE SIZE	<125 PSIG	<50 PSIG	<250 PSIG
1"–2.5"	6"	12"	15"/18"
3"–4"	6"	12"/15"	15"/18"
6"–10"	12"	18"	18"/24"
12"–14"	12"	18"	24"
18"–24"	15"/18"	24"	24"/30"
30"–36"	24"	30"	36"

*Use SVA05 for 1/2" diameter probe and SVA07 for 3/4" diameter probe and sensor

Flow Sizing

The two most common applications for Sage Flow Meters is for measurement of air and natural gas. The following charts indicate the Maximum Full Scale Flow Rates for these gases in different pipe sizes (see below for Minimum Full Scale Flow Rates).

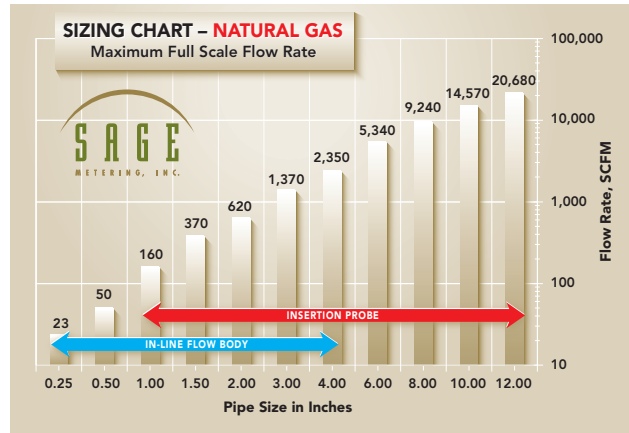
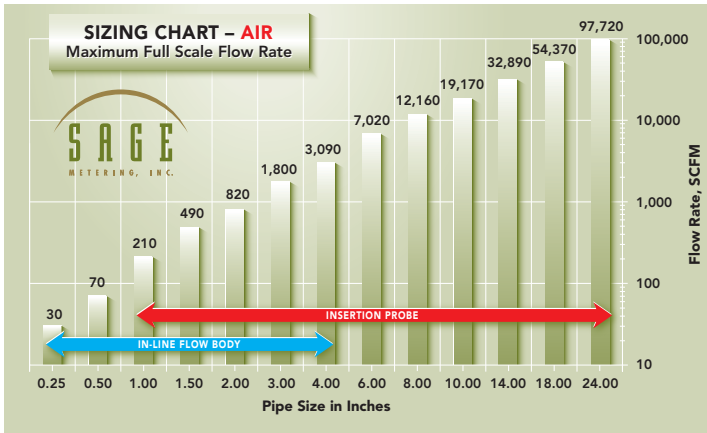

Full Scale Flow Rates of Common Gases Based on Pipe Size in Inches. Minimum Full Scale Flow Rate can be as low as 5% of Maximum Full Scale Flow Rate and will still maintain a 100:1 turndown. The accuracy of +/-0.5% of Full Scale +/-1% of Reading applies over the full turndown.¹ All calibrations begin at no flow (0 SCFM).

Principle of Operation

Sage Thermal Mass Flow Meters measure heat transfer as the gas flows past a heated surface. Two platinum RTD sensors are clad in a protective sheath. The flow sensor is self-heated while the second sensor measures the temperature of the gas. As gas flows past the heated flow sensor the gas molecules carry heat away from the surface. The Sage proprietary sensor drive circuit replenishes the lost energy by heating the flow sensor to maintain the desired temperature difference over the entire temperature range of the instrument. The power required to maintain this temperature differential is proportional to the mass flow rate. The inherently non-linear signal provides excellent low flow sensitivity and high turndown capabilities. The signal is linearized to provide the output signal from the flow meter.

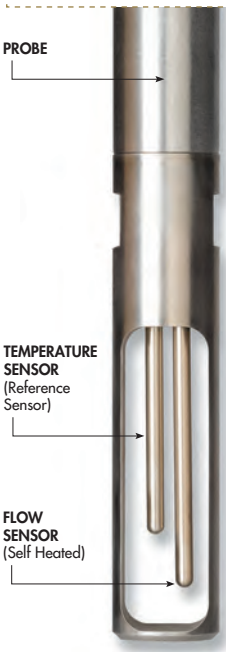

The Sage proprietary sensor drive circuit replenishes the lost energy by heating the flow sensor to maintain the desired temperature difference over the entire temperature range of the instrument. The power required to maintain this temperature differential is proportional to the mass flow rate. The inherently non-linear signal provides excellent low flow sensitivity and high turndown capabilities. The signal is linearized to provide the output signal from the flow meter.

output signal from the flow meter.

Calibration

Calibration is an essential portion of any thermal mass flow meter. The calibration establishes the relationship between mass flow and the power

required to maintain the specified temperature difference. For best accuracy, 10–15 flow points are taken with the actual gas in Sage’s NIST traceable calibration facility, and 11 samples are recorded for each point.

In-Situ Calibration Verification

One of the challenges with any thermal mass flow meter is to verify the instrument’s calibration. This is possible on the Paramount™ and Prime™ if just one of the calibration data points can be checked during normal operation. Sage has developed a unique method which permits the user to verify the calibration without having to shut down or remove the sensor from the process. This “in-situ” process is accomplished in three easy steps – **Loosen, Lift, and Look** (see below). This permits the user to

STEP 1 LOOSEN Simply Loosen the Valve Assembly’s Lower Collar Clamp and Slightly Loosen Its Compression Fitting

STEP 2 LIFT Lift the Probe Until the Safety Chain is Taut, and Then Close the Valve as Shown in the Inset

STEP 3 LOOK Look at the Milliwatt (mW) Reading on the Display (A), and Merely Compare it to the Flow Meter’s Tag (B)

The In-Situ Calibration Check, conveniently performed at a “No Flow” (0 SCFM) condition, verifies the sensor’s performance, its cleanliness, and the Flow Meter’s operation and calibration.

The 3-Step In-Situ Field Check is the Easy, Cost-Effective Way to Verify the Meter’s Calibration

obtain a “no flow” data point which can be compared against the original factory calibration listed on the name plate and on the calibration certificate. When the measured signal matches the original NIST traceable calibration data, the accuracy of the entire range of the meter is verified. For more information visit www.sagemetering.com

¹Maximum Flow Rate accuracy on 1-1/2”, 2”, 2-1/2”, and 3” pipes slightly derated due to extrapolation



***Make the Wise Choice.
Choose Sage Flow Meters.***



Scan for Website

8 Harris Court, Bldg D / Monterey, CA 93940
866-677-SAGE (7243) / TEL 831-242-2030 / FAX 831-655-4965
www.sagemetering.com



Scan for Sage Paramount™
Industrial Thermal Mass
Flow Meter Flyer



Scan for SageCom™
Validation and
Configuration Flyer



Scan for Sage Prime™
Thermal Mass Flow
Meter Flyer